

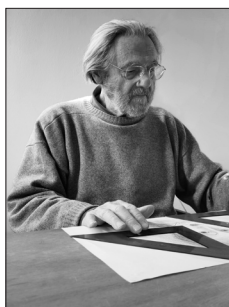

**Scarpa 925**

**Design** Afra & Tobia Scarpa

**Year** 1966



**Afra & Tobia Scarpa**

Afra Bianchin (1937-2011) and Tobia Scarpa (1935-) first met at the IUAV, University of Venice, where they graduated as architects in 1957. This marked the beginning of a partnership, marriage, and a career with an impressive impact on Italian design in the 1970s and 1980s. The Scarpa's influenced the golden years of design and production 'Made in Italy' with their modernist aesthetic and constant focus on the technical and aesthetic possibilities of materials in their designs. Their work consists of architecture, everyday household items, art glass, and exclusive home interior design pieces.



The iconic 925 Scarpa lounge chair is a strikingly elegant lounge chair. Easily recognized by its firm and robust wooden frame and the striking contrast it creates to the lightness of the leather covered seat and backrest.

The anatomical design of the leather-covered seat, combined with the natural elasticity of the cantilevered backrest, creates a lounge chair that is equally comfortable and strikingly elegant.

The 925 Scarpa lounge chair was designed alongside the charming 121 Scarpa dining chair from 1965. The two chairs are a prime example of Afra and Tobia Scarpa's work and share the same double trestle structure with characteristic rounded joints. Both designs are now a part of the Karakter collection.

**PRODUCT DATA**

Design	Afra & Tobia Scarpa. 1966
Product type	Lounge chair
Environment	Indoor
Materials	Frame in solid ash, HR/Cal.117 foam, upholstery in saddle leather, plastic glides

**CMHR FOAM**

CMHR foam available

**DELIVERY - LAUNCHES SEPTEMBER 2025**

Lead time	16 to 18 weeks
-----------	----------------

**VERSIONS IN STOCK**

203313	Scarpa 925 - Natural ash frame - HR/Cal.117 foam - Naturale C16 saddle leather - Plastic glides
203333	Scarpa 925 - Mocca stained ash frame - HR/Cal.117 foam - Moka C11 saddle leather - Plastic glides

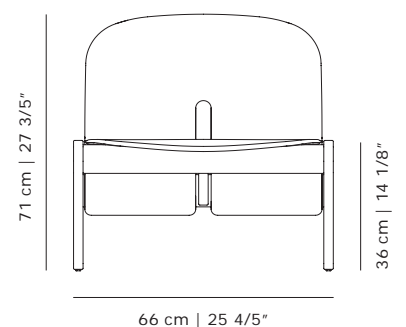
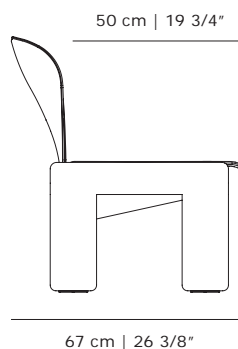



## Scarpa 925

Frames and upholstery

### Frames

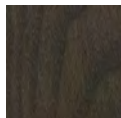

Solid ash  
mocca stained



Solid ash  
natural

### Upholstery - Saddle leather

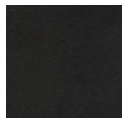

Nero C09

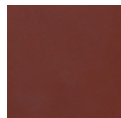

London C05



Naturale C16

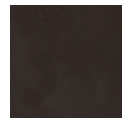

Moka C11



Cognac C22



Founded on rebellious curiosity and a passion for the unique, Karakter is a bit out of the ordinary. Rooted in the proud Danish design tradition, but always maintaining an international outlook, Karakter presents a striking portfolio of furniture, lighting and objects from designers who have already written the history of design to those who are aspiring to write the future. All designers collaborating with Karakter are curated for their ideas and creativity and shared by all of them is an inspiring level of curiosity and an uncompromising take on their work. Boasting both the relevant and honest, the beautiful, the playful and the expressive, all designs have a clear, undeniable character. Ready to spark curiosity and start conversations.

**Head Office**

Karakter  
 Gammel Lundtoftevej 1C  
 2800 Kongens Lyngby  
 Denmark

T +45 38 41 41 31  
 @karaktercopenhagen  
 info@karakter-copenhagen.com