

ALBA

BY BERNHARDT & VELLA

2018

Categoria
Struttura
Supporto ripiano
Ripiano
Ripiano

Kit fermalibri
Ring contenitore
Piedini

Category
Structure
Shelf support
Shelf
Shelf

Bookend kit
Storage ring
Feet

Catégorie
Structure
Support étagère
Étagère
Étagère

Kit serre-livres
Anneau conteneur
Pieds

Kategorie
Struktur
Regalstütze
Regal

Regal

Bücherstützenkit
Behälterring
Füße

Librerie.
Alluminio anodizzato nero.
Ottone satinato. Snodabile.
Vetro temperato nei colori verde, fumé o bronzo. Disponibile L. 70 cm.
Alluminio anodizzato satinato o alluminio anodizzato satinato nero.
Disponibile L. 70 - 90 cm.
Ottone satinato. Disponibile per ripiani in alluminio L. 70 - 90 cm.
Ottone satinato. Disponibile per ripiano in alluminio L. 70 cm.
Ottone satinato e gommino nero.
Versioni disponibili con fissaggio a soffitto o a parete.
E' possibile combinare ripiani in vetro e in alluminio nella stessa composizione.
Versione a parete disponibile solo con ripiani in alluminio o alluminio e vetro, solo ripiani in vetro non disponibile.
Nella versione a parete con ripiani in alluminio e vetro, ogni modulo dovrà avere minimo 2 ripiani in alluminio.
Ogni modulo della composizione dovrà avere un minimo di 4 ripiani, fino ad un massimo di 6.
E' obbligatorio fissare i montanti a soffitto o a parete.

Bookcases.
Black anodized aluminium.
Satin brass. Jointed.
Tempered glass in the colours green, fumé or bronze. Available W. 70 cm.
Satin anodized aluminium or black satin anodized aluminium.
Available W. 70 - 90 cm.
Satin brass. Available for aluminium shelves W. 70 - 90 cm.
Satin brass. Available for aluminium shelf W. 70 cm.
Satin brass and little black rubber.
Versions available with ceiling fixing or wall fixing.
It is possible to mix glass and aluminium shelves in the same composition.
Wall fixing version available only with aluminium shelves or mix of aluminium and glass shelves, version with only glass shelves not available.
In the wall fixing version with glass and aluminium shelves, each module must have at least 2 aluminium shelves.
Min. 4 shelves and max. 6 shelves for each composition module.
Uprights must be always fixed to the ceiling or to the wall.

Bibliothèques.
Aluminium anodisé noir.
Laiton satiné. Articulé.
Verre trempé dans les coloris vert, fumé ou bronze. Disponible L. 70 cm.
Aluminium anodisé satiné ou aluminium anodisé satiné noir.
Disponibile L. 70 - 90 cm.
Laiton satiné. Disponible pour étagères en aluminium L. 70 - 90 cm.
Laiton satiné. Disponible pour étagère en aluminium L. 70 cm.
Laiton satiné et caoutchouc noir.
Versions disponibles avec fixation au plafond ou au mur.
Dans la même composition, il est possible de combiner des étagères en verre et en aluminium.
Version avec fixation au mur disponible seulement avec étagères en aluminium ou aluminium et verre, pas uniquement avec étagères en verre.
Dans la version avec fixation au mur avec étagères en aluminium et en verre, chaque module doit avoir au moins 2 étagères en aluminium.
Chaque module de la composition doit avoir un minimum de 4 étagères, jusqu'à un maximum de 6.
Il est obligatoire de fixer les montants au plafond ou au mur.

Bücherregale.
Schwarz eloxiertes Aluminium.
Satiniertes Messing. Gelenkig.
Gehärtetes Glas in den Farben grün, rauch oder bronze. L. 70 cm verfügbar.
Satiniertes eloxiertes Aluminium oder schwarz satiniertes eloxiertes Aluminium. L. 70 - 90 cm verfügbar.
Satiniertes Messing. Für Aluminiumregale L. 70 - 90 cm verfügbar.
Satiniertes Messing. Für Aluminiumregal L. 70 cm verfügbar.
Satiniertes Messing und schwarzer Gummi.
Versionen mit Decken- oder Wandbefestigung verfügbar.
Es ist möglich, Glas- und Aluminiumregale in derselben Zusammensetzung zu kombinieren.
Wandversion mit nur Regalen aus Aluminium oder Aluminium und Glas (nicht mit nur Regalen aus Glas) verfügbar.
Bei der Wandversion mit Aluminium- und Glasregalen muss jedes Modul mindestens 2 Aluminiumregale haben.
Jedes Modul der Zusammensetzung muss mindestens 4 Regale haben, bis zu einem Maximum von 6.
Es ist zwingend erforderlich, die Stützen an die Decke oder an die Wand zu befestigen.



Alba bookcase composition - ceiling fixing version

Goya table

Botolo chair

Marengo armchair

VERSO

51 Hudson St, New York NY 10013 | www.verso-works.com



Alba bookcase composition - ceiling fixing version
Marenco armchair



Alba bookcase composition - ceiling fixing version
9000 armchair



Alba bookcase composition - wall fixing version



Alba bookcase composition - wall fixing version

Marengo armchair

Scalea small table

Radia freestanding



Alba bookcase composition - wall fixing version

Elettra armchair – capsule collection Dedale 3

Tablet small table

Radia freestanding



Alba bookcase composition - wall fixing version

ALBA



Versione fissata a parete
Wall fixing version
H. from 246 cm to 270 cm / 97" to 106 1/4"



Versione fissata a soffitto
Ceiling fixing version
H. from 240 cm to 300 cm / 94 1/2" to 118 1/4"

Tipologie ripiano
 Shelf typology

Shelf "A"

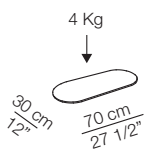

Shelf "B"

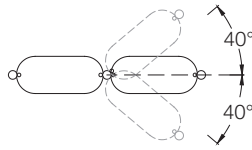
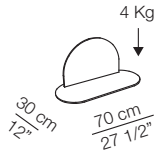

Composizione libreria con 2 moduli
 Bookcase composition with 2 units

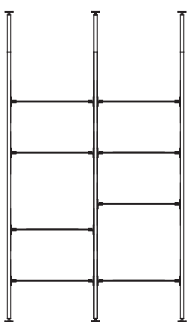

70 cm 70 cm
 27 1/2" 27 1/2"
 max. 159 cm 62 3/4"

Composizione libreria con 2 moduli
 Bookcase composition with 2 units

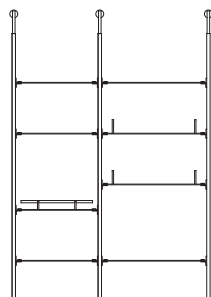

70 cm 90 cm
 27 1/2" 35 1/2"
 max. 180 cm 71"

Composizione libreria con 2 moduli
 Bookcase composition with 2 units

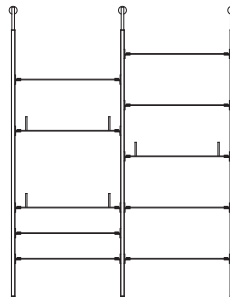

90 cm 90 cm
 35 1/2" 35 1/2"
 max. 200 cm 79"

Composizione libreria con 3 moduli
 Bookcase composition with 3 units

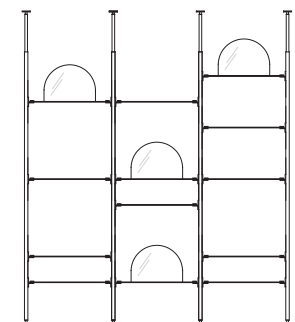

70 cm 70 cm 70 cm
 27 1/2" 27 1/2" 27 1/2"
 max. 235 cm 92 1/2"

Composizione libreria con 3 moduli
Bookcase composition with 3 units

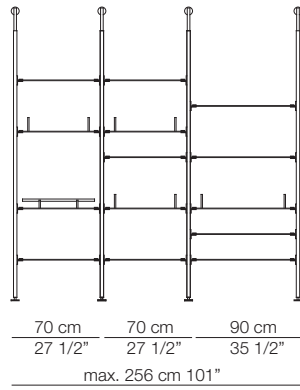

Composizione libreria con 3 moduli
Bookcase composition with 3 units

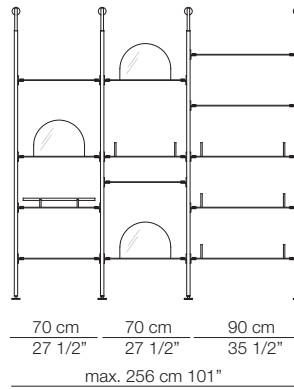

Composizione libreria con 4 moduli
Bookcase composition with 4 units

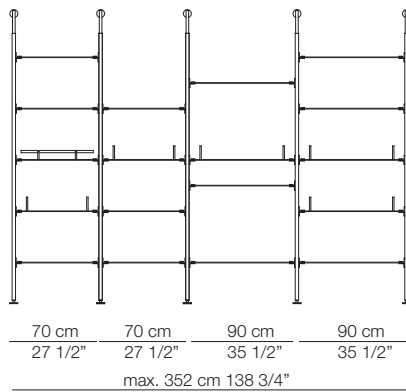

Composizione libreria con 4 moduli
Bookcase composition with 4 units

